

JAMES MORTON™

Clamps
Bessey® - Forged Steel



Include Morpad. Extra throat reach eliminates need for regular and deep throat clamps. Morpad tilts 35°.

Meet ISO 9001 requirements.

2400 Series. Draw together up to 1/2" steel plate. Throat depth 5 1/2". Clamping pressure 2660 lbs.

No.	Nom. Rail Size In.	Nom. Open In.	Wt. Lbs.
Regular Duty			
...2400S-6	1 1/16 x 9/16	6	5
...2400S-8	1 3/16 x 9/16	8	5 1/2
...2400S-10	1 1/2 x 9/16	10	5 3/4
...2400S-12	1 5/8 x 9/16	12	6
...2400S-20	1 7/8 x 9/16	20	7 1/2
...2400S-40	2 1/8 x 9/16	40	10 3/4
...2400S-60	2 3/8 x 9/16	60	14 1/4

JAMES MORTON™

Lever Clamps
Bessey® - Ratchet Action



Fast clamping action. Clamping pressure released instantly with quick release button. Ratchet makes clamp vibration proof. For fine tightening. Standard handle. Lever set in vertical position. 10 teeth.

No.	Nom. Open In.	Nom. Throat Dpth. In.	Nom. Clamp Press. Lbs.	Wt. Lbs.
...LC-4	4	2 3/8	400	3/4
...LC-6	6	3 1/8	500	3/4
...LC-8	8	4	770	1
...LC-10	10	5	880	3 1/2
...LC-12	12	6	1110	4 3/4
...LC-20	20	5	1440	5 1/2

JAMES MORTON™

Clamps
Bessey® - Medium Duty Series

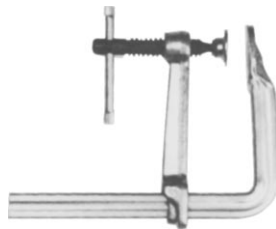

Steel. Drop-forged, heat treated, galvanized arm with laser cut rail guide to prevent slippage. Moveable sliding arm. Galvanized rail. Cover range of two or more "C" clamps. Standard pad. Raised pressure plate for secure positioning of work piece and proper distribution of clamping pressure. Tempered, high carbon, Acme threaded screw. Treated to resist weld splatter. Tommy bar handle for positive pressure. Clamping pressure 1800 lbs. Throat depth 4 3/4". Rail size 1 1/16" x 1/2".

Meet ISO 9001 requirements.

No.	Open In.	Wt. Lbs.
...SGL20	8	4
...SGL25	10	4 1/2
...SGL30	12	4 3/4
...SGL40	16	5
...SGL50	20	4 3/4
...SGL60	24	4 3/4

JAMES MORTON™

Woodworking Clamps
Bessey® - Power Grip



Wood handle. Single hand clamping lever allows one hand clamping from jaw side or rail side of work bench. Spring tempered, profiled rail for high clamping pressure. Quick release lever for rapid movement of sliding arm. Hand lever and housing made from glass fiber, reinforced industrial polymers. Nonmarring plastic pressure caps.

Clamping pressure with lever 200 lbs. Clamping pressure with handle 1000 lbs. Throat depth 4".

Meet ISO 9001 requirements.

No.	Open In.	Wt. Lbs.
/372PG4012	12	2 3/4
/372PG4024	24	3 1/2

HARGRAVE®
Pipe - Clamp Fixtures

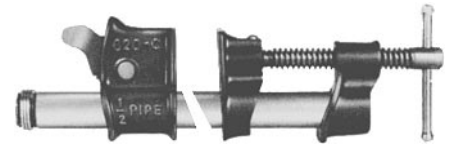

Malleable iron frame and slide. Recommended for use with extra heavy black iron pipe. Steel screw 1/2" dia. with sliding pin handle. Nonstick, nonslip slide.

No. 22202. Fits 1/2" pipe.

No. 22201. Fits 3/4" pipe.

No.	Model No.	Clamp Surface In.	Pkg. Qty.	Wt. Lbs.
...22201	22201	1 3/4	1	2 1/2
...22202	22202	1 1/2	1	1 1/2

HARGRAVE®

Body Clamps
No. 400

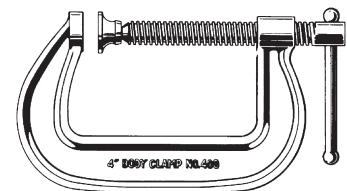

Drop-forged, heat treated. Useful for welding, other metal fabricating, and for woodwork. Frame shaped for maximum strength. Single Acme thread screw; strong, sliding pin, vise type handle; steel tip, held securely.

No.	Opening Max In.	Opening Min. In.	Dpth. In.*	Test Load Lbs.	Wt. Lbs.
...402	2	0	2	3500	1 1/2
...403	3	0	2 3/8	3500	1 3/4
/37220303	4	0	2 3/4	6500	2 3/4
/37220304	6	0	3 3/8	6900	4 3/4
...408	8	0	4 1/2	6900	8 1/2
...410	10	0	5 3/8	8000	10 1/2
...412	12	0	5 3/4	9500	14

*Depth is from center of screw to frame.

HARGRAVE®

C-Clamps
No. 44 - Superclamp®

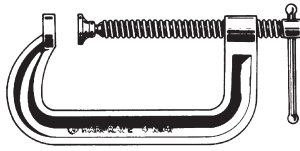

Forged steel, heat-treated frame. Vise-type sliding pin handle. Full-length large diameter screws prevent bending and thread damage. Conform to Fed. Spec. GGG-C-406D, Type 1. Class A, light service.

No.	Max Open In.	Dpth In.*	Screw Dia. In.	Test Load Lbs.	Wt. Lbs.
/37221103	2	1 3/4	1/2	2700	1
/37221104	3	2 1/4	1/2	3000	1 1/2
/37221105	4	2 1/2	5/8	3700	2 1/4
/37221106	6	3 1/8	5/8	4500	3 1/2
...21107	8	3 3/4	3/4	5200	5 1/2
...21108	10	4	7/8	6000	8
...21109	12	4 1/4	7/8	8000	9 1/2

*Depth is from center of screw to frame.

HARGRAVE®

Carriage Clamps
No. 540 - Standard

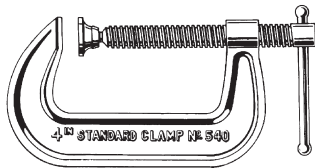

Frames constructed from high strength, ductile iron castings. Design provides sliding pin handle, single acme thread screw, and oscillating ball and socket tip. Frame shaped for greatest strength for weight.

No.	Max. Open In.	Dpth. In.*	Screw Dia. In.	Test Load Lbs.	Wt. Lbs.
/37222001	2 1/2	1 3/4	1/2	1100	1/2
/37222002	3	1 7/8	1/2	1800	1 1/4
/37222003	4	2 1/16	5/8	2150	1 1/2
/37222004	5	2 1/2	5/8	2250	2 1/4
/37222005	6	2 3/4	5/8	2450	2 1/2
/37222006	8	3 1/4	3/4	2750	3 1/2
/37222007	10	3 3/8	7/8	2250	6 1/2
...22008	12	3 5/8	7/8	2850	8
...22009	14	3 3/4	7/8	2850	9

*Depth is from center of screw to frame.

HARGRAVE®

C-Clamps
Super-Junior®



Forged steel. Plated steel screw. For all classes of work.

Conform to Federal Specification GGG-C-406D, Type 1, Class E, very light service.

No.	Model No.	Open In.	Dpth. In.*	Test Load Lbs.	Wt. Lbs.
/37221301	50	1	1	500	1/4
/37221302	51	1	1 1/2	500	1/4
/37221303	52	1 1/4	1 1/4	800	1/4
/37221304	53	1 1/2	1 1/2	850	1/4
/37221305	54	2	1 1/4	875	1/4
/37221306	55	3	1 3/8	1100	1/2
/37221307	56	2 1/2	2 1/2	850	1/2

*Depth is from center of screw to frame.

TOGGLE CLAMPS

Vertical Handle

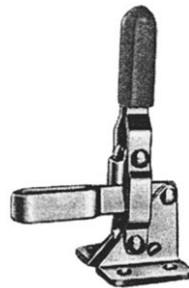

Miniature. U-bar, flanged base with straight handle. Handle moves 56°, bar 100°. Supplied with neoprene tipped spindle assembly. Red vinyl hand grip.

No.	Holding Cap. Lbs.	Wt. Oz.
/390CL150VTC	100	2

TOGGLE CLAMPS

Horizontal Handle



U-bar. Flanged base. Handles moves 65°, bar 90°. Supplied with neoprene tipped spindle assembly. Red vinyl hand grip.

No.	Holding Cap. Lbs.	Wt. Oz.
/390CL450HTC	500	9.4

TOGGLE CLAMPS

Horizontal Handle

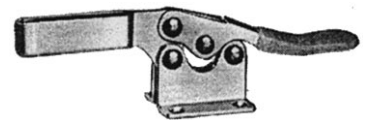

Low profile. U-bar. Flanged base. Handle moves 60°, bar 85°. Supplied with neoprene tipped spindle assembly. Red vinyl hand grip.

No.	Holding Cap. Lbs.	Wt. Oz.
/390CL350HTC	200	6

TOGGLE CLAMPS

Latch Type



Flanged base. Red vinyl hand grip.

No.	Holding Cap. Lbs.	Wt. Oz.
/390CL250PA	375	

A number of items in this catalog are listed in condensed form.
Complete catalogs and specifications will be sent to you on request.
Please call us.

TOGGLE CLAMPS
Vertical Handle

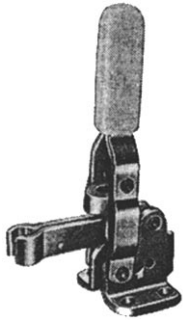

Fixed spindle. Flanged base with straight handle. Handle moves 60°, bar 100°. Supplied with neoprene tipped spindle assembly. Red vinyl hand grip.

No.	Holding Cap. Lbs.	Wt. Oz.
/390CL250VTC	200	6

TOGGLE CLAMPS
Push-Pull

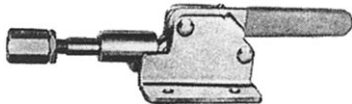

Low profile. Reverse action. Plunger locks in extended position only. Handle moves 45°. Plunger travels 1/2". Red vinyl hand grip.

Complete Information Available on Request.

TOGGLE CLAMPS
Latch Type

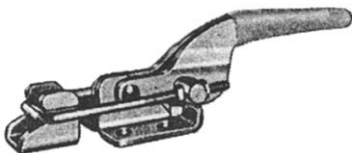

Supplied with latch plate. Red vinyl hand grip.

Complete Information Available on Request.

TOGGLE CLAMPS
Horizontal Handle

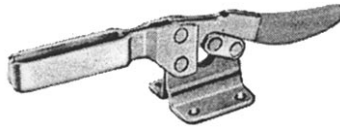

Low profile. U-bar. Flanged base. Handle moves 50°, bar 85°. Supplied with neoprene tipped spindle assembly. Red vinyl hand grip.

Complete Information Available on Request.

WORM GEAR CLAMPS
Mini Clamps® - SAE Type "M"
5/16" Wide



Premium. Stainless steel band, saddle and housing. Slotted hex head screw 1/4". Tighten with circumferential pressure. Maximum torque 25 in./lbs.

No.	SAE Ref. No.	Min. Dia. In.	Max. Dia. In.
Series 400 - Stainless Steel Screws			
/375M04S	4	1/4	5/8
/375M05S	6/8	5/16	29/32
/375M10S	10	1/2	1 1/16

MURRAY CORP.
Worm Gear Clamps
1/2" Wide



Band and housing 201 stainless steel construction with 5/16" slotted hex head shouldered screw.

Series 400. Magnetic stainless steel screw. High corrosion resistance. For plastic pipe and industrial applications.

Series 400 - Stainless Steel Screws

No.	Min. Dia. In.	Max. Dia. In.
/375B06HS	7/16	25/32
/375B08HS	7/16	29/32
/375B10HS	9/16	1 1/16
/375B12HS	1 1/16	1 1/4
/375B16HS	3/4	1 1/2
/375B20HS	13/16	1 3/4
/375B24HS	1 1/16	2
/375B28HS	1 5/16	2 1/4
/375B32HS	1 9/16	2 1/2
/375B36HS	1 13/16	2 3/4
/375B40HS	2 1/16	3
/375B44HS	2 5/16	3 1/4
/375B48HS	2 9/16	3 1/2
/375B52HS	2 13/16	3 3/4
/375B56HS	3 1/16	4
/375B60HS	3 5/16	4 1/4
/375B64HS	3 9/16	4 1/2
/375B72HS	4 1/16	5
/375B80HS	4 9/16	5 1/2
/375B88HS	5 1/16	6
/375B96HS	5 9/16	6 1/2
/375B104HS	6 1/16	7
/375B116HS	6 13/16	7 3/4

HOSE CLAMPS















Gear type, permit quick hose repair with simple tools. Plated steel screw, stainless brand.

No.	Hose OD Rng. In.	Clamp Width In.
/910355	3/8 to 7/8	5/16

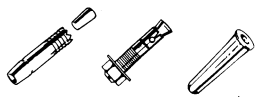
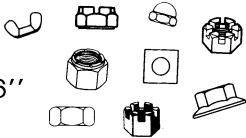

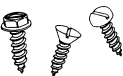



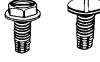

MATERIALS NOT LISTED

All the goods we can furnish are not listed in this catalog. If you do not find everything you need, please advise us and we will promptly send manufacturers' catalogs.



FASTENERS

- All Specials
- USS, SAE & Metric
- Plain, Plated, Brass, Stainless & Nylon
- Carriage Bolts 
- Eye Bolts 
- Hex Head Cap Screws: 2, 5, 8, A325 & L9 
- Lag Screws 
- Machine Screws 
- Masonry Anchors: All Types 
- 
- Nuts: All Types 2/56 thru 6" 
- Pins: Cotter, Dowel Roll (Tension) & Taper
- Rivets 
- Sheet Metal Screws 
- Socket Head Cap Screws 
- Socket Head Shoulder Screws 
- Socket Pipe Plugs 
- Socket Set Screw 
- Square Head Set Screws
- Studs — Low Carbon & B7







FASTENERS (Cont'd.)

- Tapping Screw Type F 
- Tek Screw 
- Threaded Rod: 3', 6', 12' Lengths Steel, B7, Brass, Stainless Metric, Left Hand, Nylon & Acme
- Washers:
 - A325 
 - Beveled 
 - Fender 
 - Flat 
 - Lock 
- Wood Screws 

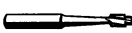

GRINDING WHEELS

- Bench Grinding Wheels
- Carbide
- Cut Off Wheels
- Mounted Points 
- Type 27 & 28 
- Vitrified Wheels



MISC. CUTTING TOOLS

- Broaches 
- Counterbores 
- Countersinks 
- Files 
- File Cards
- File Handles 
- Milling Cutters 

MISC. CUTTING TOOLS (Cont'd.)

- Reamers 
- Sq. & Rec. Tool Bits 

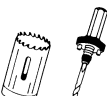
SAW BLADES

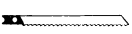
- Band Saw 
- Hack Saw & Frames 
- Hole Saw & Arbors 
- Power Hack Saw
- Reciprocating Saw 





STORAGE CABINETS

- Drawers
- 40, 56 & 72 Hole Bins 
- Storage Systems

TAPES

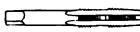
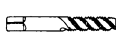
- Duct
- Filament
- Masking
- Pressure Sensitive Carton Closure (Polypropylene & PVC)
- Strapping

TAPS & DIES

- All Special Taps & Dies
- Acme 
- Fast Spiral 
- Hand 
- Machine Screw
- Pipe Taps
- Spiral Point 
- Slow Spiral 
- Hex Rethread Dies 
- Round Dies 